

Data Sheet



Article number: 2011461020

Description: E+G Stainless steel lock pin
GN 114.6-10-20

Measures

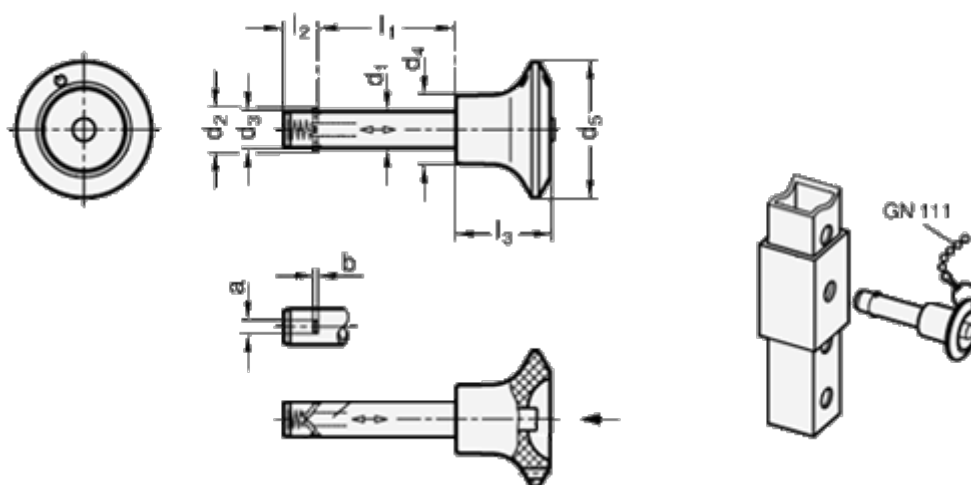

a = 3.3	l3 = 26
d1 = 10	Resilience (N) = 38
d2 = 12.8	
d3 = 9.9	
d4 = 18.0	
d5 = 34	
l1 = 20	
l2 = 9.8	